



Joule

Joule is a series of elegant magnetic track lights, with three unique and independent options to cater to the individual's needs. Exclusive Ultra thin (Invi) and Ultra slim (Discreet) variants with decorative options that have the power to change the whole aesthetic look of the space.



Project - Private Residence
Mumbai, India

Joule Invi Magnetic - Features

10MM

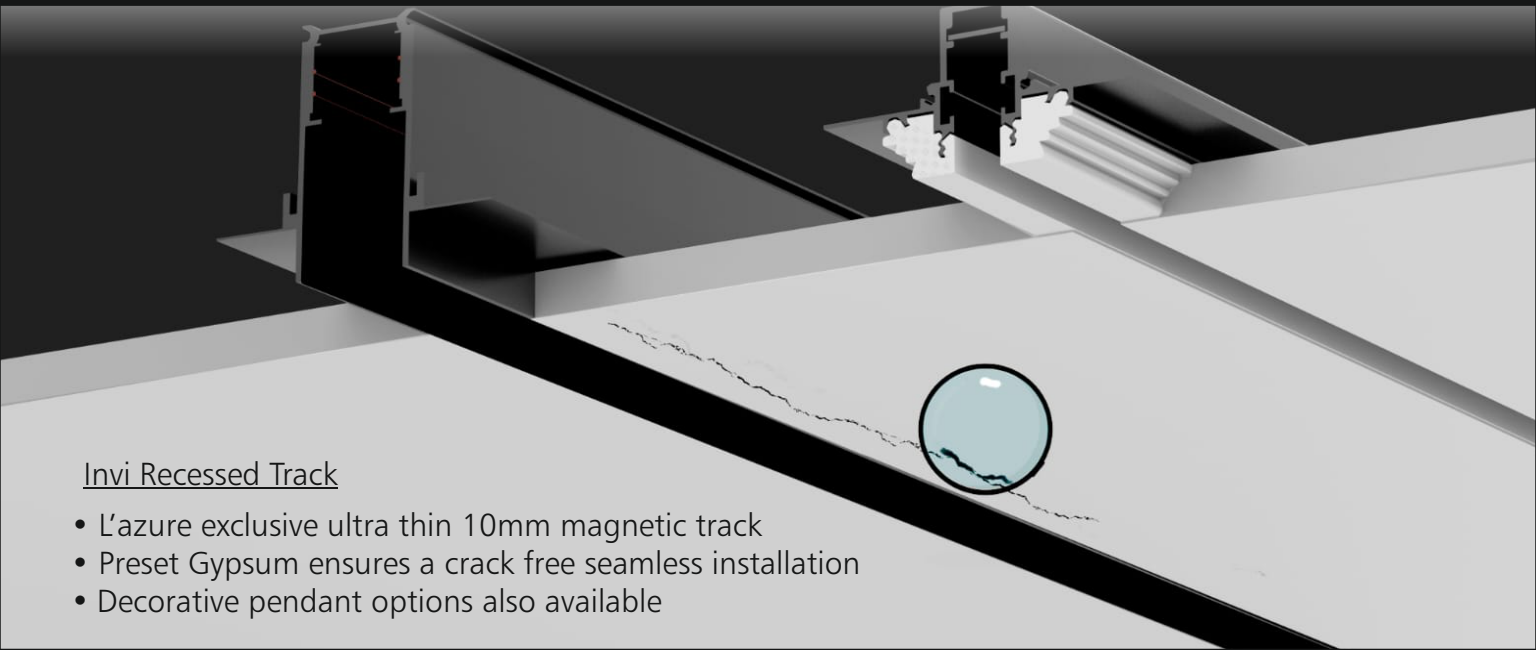
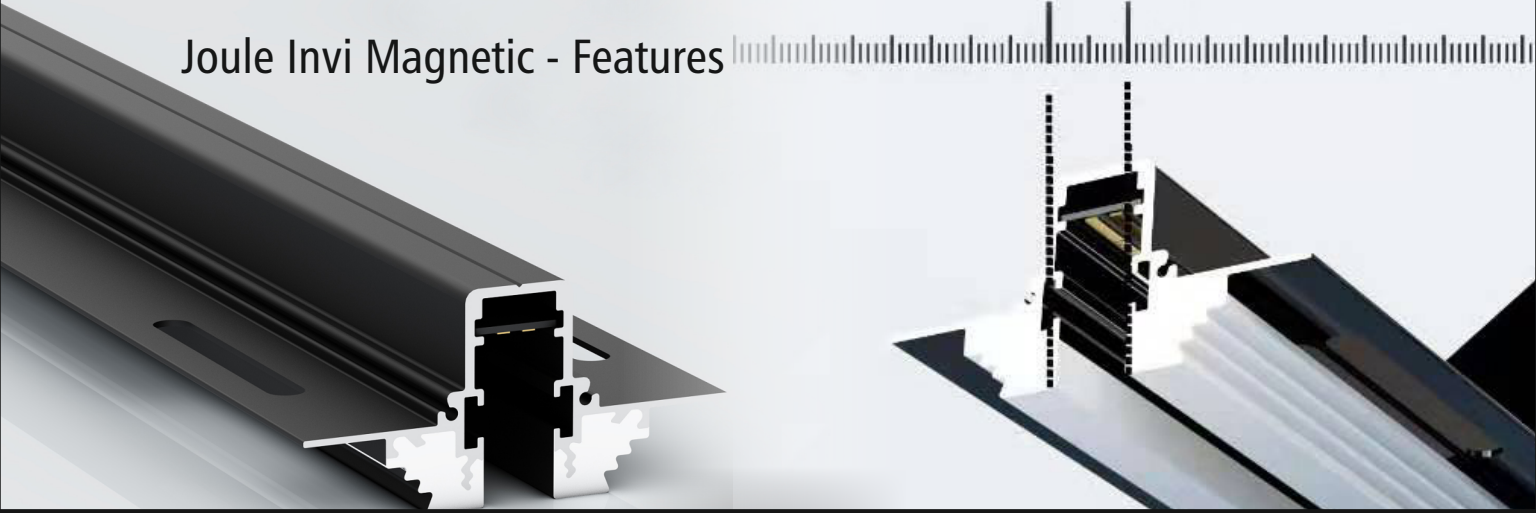

Invi Recessed Track

- L'azure exclusive ultra thin 10mm magnetic track
- Preset Gypsum ensures a crack free seamless installation
- Decorative pendant options also available



Invi Pendant Track

- L'azure exclusive ultra thin 10mm magnetic track
- 2 Installation Methods : Pendant & Surface
- Up-lighting option available
- Decorative pendant options also available

Joule Invi Magnetic - Track



Invi Pendant Track
#2071

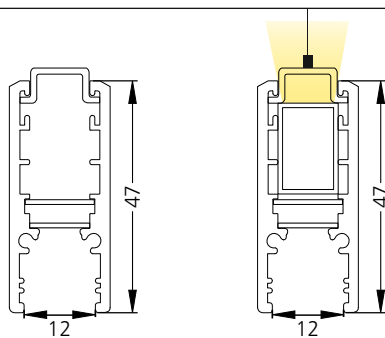

Note :-
For up-lighting, Top Bend S Flexum is mounted into the Joule Invi Pendant Track

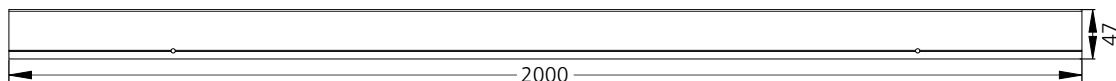

Flat Corner



Inner Corner

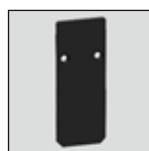

End Cap



Connectors

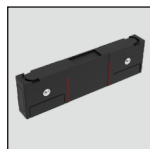

I Jointer Module



Mounting Clamp



Input Module



Suspension Kit

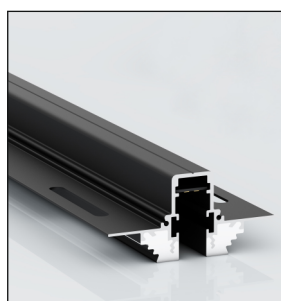

Invi Recessed Track
#2072

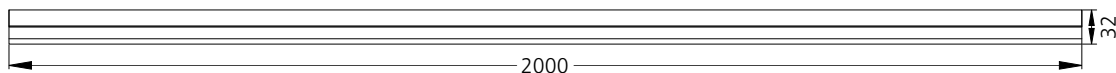
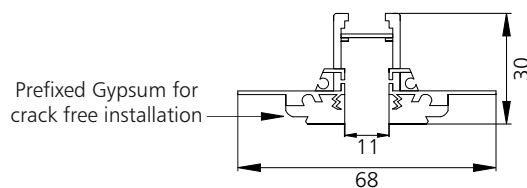

Flat Corner



Inner Corner



End Cap



Connectors

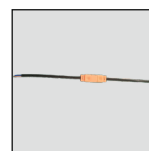

"L" Male Female Connector



Input Module

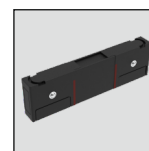

I Jointer Module



Project - Private Residence
Dubai, UAE

Joule Invi Magnetic - Modules

LED	Typ CRI	Body Finish	Interior Finish	IP Rating	Dimming Options	Filter Options
Array 2 Step MacAdam L90-B10 60,000Hrs	95	Matt Black	Matt Black Matt Gold	IP20	Non Dim	Honeycomb

Joule Invi Magnetic Modules Spot

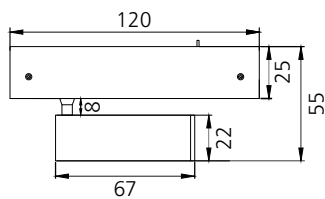
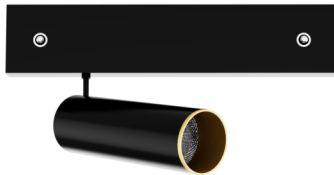

Invi S - Spot 22
#2227

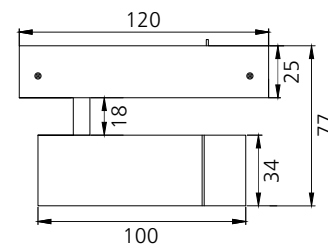

Invi M - Spot 34
#2228

Power	3W - 24V
Lumen / CCT	254lm - 2700K 258lm - 3000K 267lm - 4000K
UGR	<19
Beam Angle	24°
Driver Placement	Remote

Power	8W - 24V
Lumen / CCT	678lm - 2700K 687lm - 3000K 712lm - 4000K
UGR	<19
Beam Angle	24°
Driver Placement	Remote

Joule Invi Magnetic - Modules

LED	Typ CRI	Body Finish	IP Rating	Dimming Options	Filter Options
Mid Power 3 Step MacAdam L90-B10 60,000Hrs	92	Matt Black	IP20	Non Dim	NA

Joule Invi Magnetic Modules Diffused

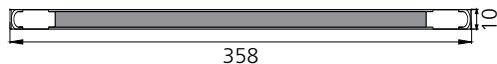

358



578

Invi M - Diffused 358
#2229

Invi L - Diffused 578
#2230

Power	9W - 24V	18W - 24V
Lumen / CCT	691lm - 2700K 707lm - 3000K 738m - 4000K	1382lm - 2700K 1414lm - 3000K 1476lm - 4000K
UGR	<19	<19
Beam Angle	Diffused	Diffused
Driver Placement	Remote	Remote

Joule Invi Magnetic - Modules

LED	Typ CRI	Body Finish	Reflector Finish	IP Rating	Dimming Options	Filter Options
High Power 3 Step MacAdam L90-B10 60,000Hrs	92	Matt Black	Matt Black	IP20	Non Dim	NA

Joule Invi Magnetic Modules Grid

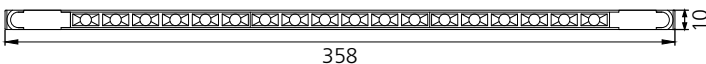
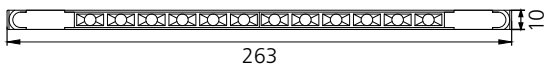

Invi S - Grid 263
#2231

Invi M - Grid 358
#2232

Power	5W - 24V	7W - 24V
Lumen / CCT	416lm - 2700K 424lm - 3000K 443lm - 4000K	582lm - 2700K 596lm - 3000K 622lm - 4000K
UGR	<19	<19
Beam Angle	24°	24°
Driver Placement	Remote	Remote

Joule Invi Magnetic - Modules

LED	Typ CRI	Body Finish	Reflector Finish	IP Rating	Dimming Options	Filter Options
High Power 3 Step MacAdam L90-B10 60,000Hrs	92	Matt Black	Matt Black	IP20	Non Dim	NA

Joule Invi Magnetic Modules Grid

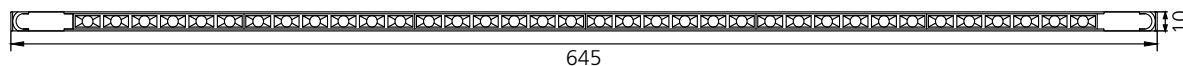

Invi L - Grid 645
#2233

Power	15W - 24V
Lumen / CCT	1247lm - 2700K 1277lm - 3000K 1334lm - 4000K
UGR	<19
Beam Angle	24°
Driver Placement	Remote

Joule Invi Magnetic - Modules

LED	Typ CRI	Body Finish	Reflector Finish	IP Rating	Dimming Options	Filter Options
High Power 3 Step MacAdam L90-B10 60,000Hrs	92	Matt Black	Matt Black	IP20	Non Dim	NA

Joule Invi Magnetic Modules Tilt Grid

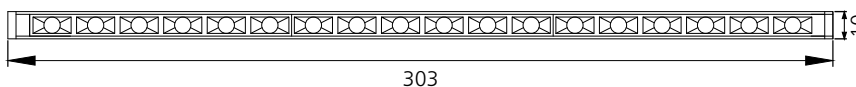

Invi M - Tilt Grid 303
#2234

Power	8W - 24V
Lumen / CCT	664lm - 2700K 681lm - 3000K 711lm - 4000K
UGR	<19
Beam Angle	24°
Driver Placement	Remote

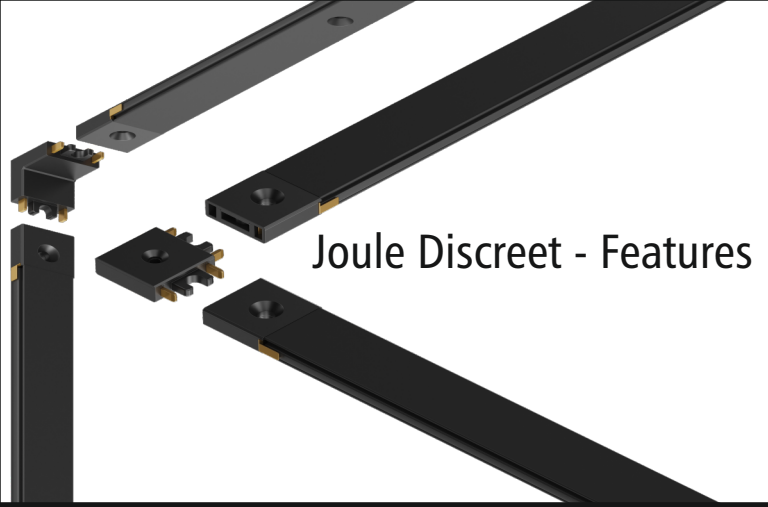

Joule Discreet - Features



L'azure Exclusive
Ultra slim "7mm" modular
magnetic track.

No visible Track lines or
grooves. A plain surface
that blends with your
ceiling



Joule Discreet Magnetic - Track

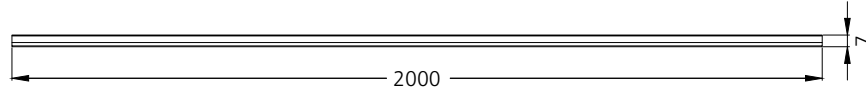
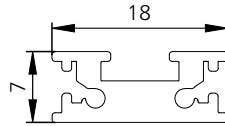

Discreet Surface Track
#2248



Wall Hanging
Swinging Head



Head Module



I Jointer



Corner Module



Inward Corner
Module

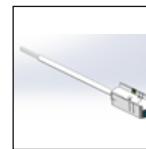

Input Module

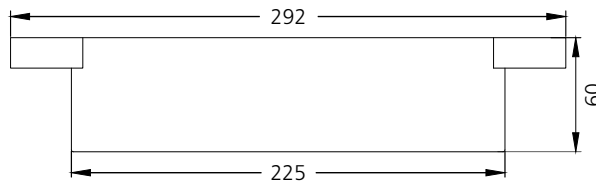
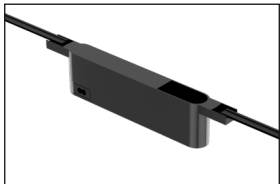

Power | 150W - 48V

Discreet - Power Supply
#2251

Joule Discreet Magnetic - Modules

LED	Typ CRI	Body Finish	Reflector Finish	IP Rating	Dimming Options	Filter Options
High Power 3 Step MacAdam L90-B10 60,000Hrs	92	Matt Black	Matt Black	IP20	Non Dim	NA

Joule Discreet Magnetic Modules

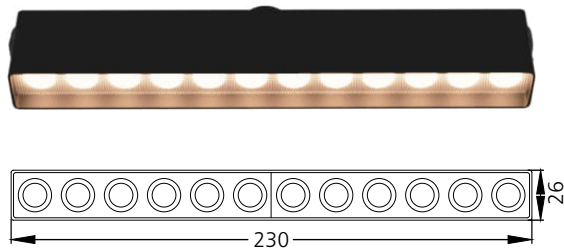

Discreet - Grid 230
#2235

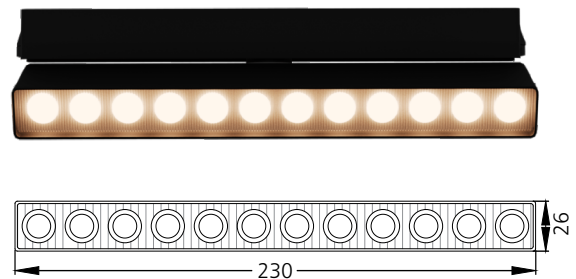

Discreet - Tilt Grid 230
#2239

Power	12W - 48V
Lumen / CCT	997lm - 2700K 1021lm - 3000K 1067lm - 4000K
UGR	<19
Beam Angle	15° 24° 38°
Driver Placement	Remote

Power	12W - 48V
Lumen / CCT	997lm - 2700K 1021lm - 3000K 1067lm - 4000K
UGR	<19
Beam Angle	15° 24° 38°
Driver Placement	Remote

Joule Discreet Magnetic - Modules

LED	Typ CRI	Body Finish	IP Rating	Dimming Options	Filter Options
Mid Power 3 Step MacAdam L90-B10 60,000Hrs	92	Matt Black	IP20	Non Dim	NA

Joule Discreet Magnetic Modules

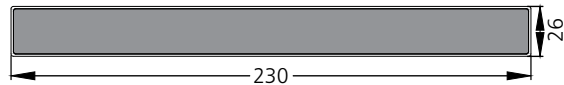
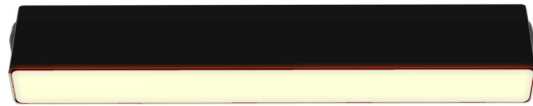

Discreet - Diffused 230
#2236

Power	9W - 48V
Lumen / CCT	691lm - 2700K 714lm - 3000K 749lm - 4000K
UGR	< 19
Beam Angle	Diffused
Driver Placement	Remote

Joule Discreet Magnetic - Modules

LED	Typ CRI	Body Finish	Interior Finish	IP Rating	Dimming Options	Filter Options
Array / High Power 3 Step MacAdam L90-B10 60,000Hrs	92	Matt Black	Matt Black	IP20	Non Dim	NA

Joule Discreet Magnetic Modules

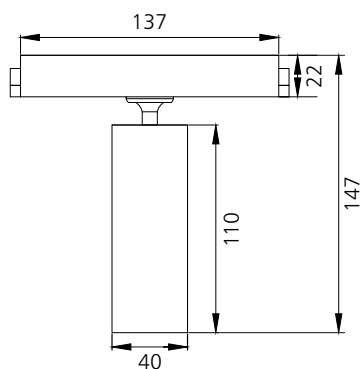
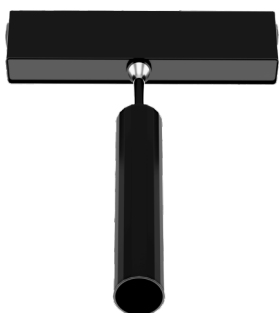

Discreet - Track Light
#2237

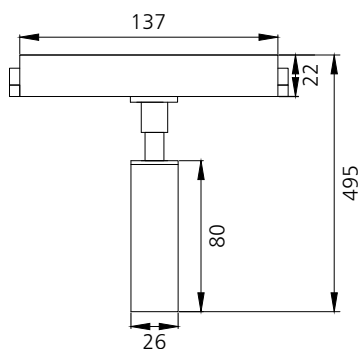
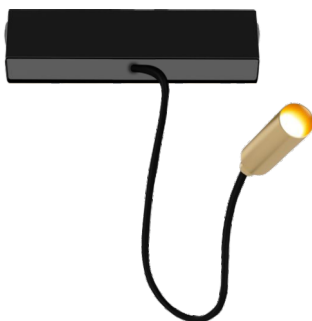

Discreet - Reading Light
#2238

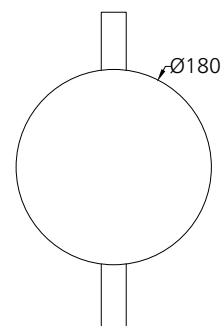
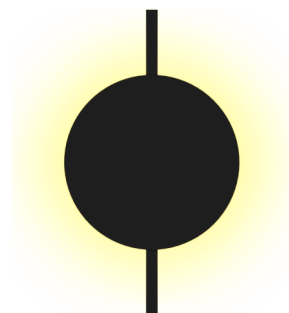

Discreet - Wall Light
#2240

Power	7W - 48V
Lumen / CCT	592lm - 2700K 601lm - 3000K 632lm - 4000K
UGR	< 19
Beam Angle	15° 24° 38°
Driver Placement	Remote

Power	2W - 48V
Lumen / CCT	166lm - 2700K 171lm - 3000K 177lm - 4000K
UGR	< 19
Beam Angle	15° 24° 38°
Driver Placement	Remote

Power	5W - 48V
Lumen / CCT	384lm - 2700K 396lm - 3000K 418lm - 4000K
UGR	< 19
Beam Angle	Diffused
Driver Placement	Remote

Joule Discreet Magnetic - Modules

LED	Typ CRI	Body Finish	IP Rating	Dimming Options	Filter Options
Mid Power 3 Step MacAdam L90-B10 60,000Hrs	92	Matt Black	IP20	Non Dim	NA

Joule Discreet Magnetic Modules

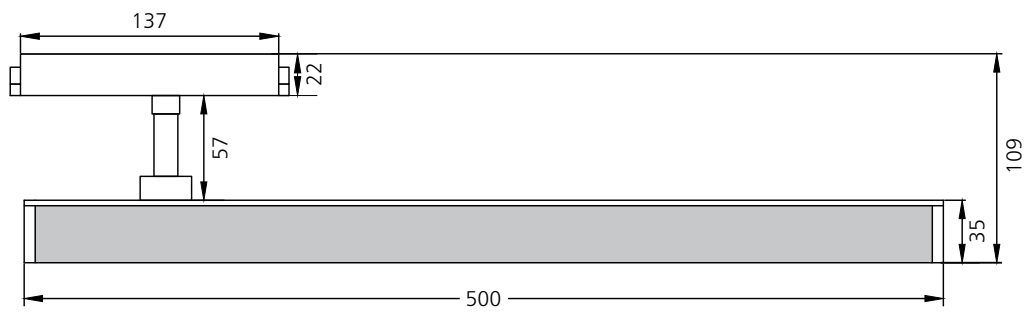

Discreet - Tube 500
#2241

Power	12W - 48V
Lumen / CCT	922lm - 2700K 951lm - 3000K 1004lm - 4000K
UGR	<19
Beam Angle	Diffused
Driver Placement	Remote

Joule Standard Magnetic - Features

Magnetic modular track based system with the option to add downlight modules, wallwash modules, diffused linear modules and even blanks where no light is needed.



Wash

- Linear Wallwash Optic
- Uniform Wall Covering
- Tunable White
- Stress-free anti-glare output

Spot

- 2 Sizes
- Tunable White
- Multiple Optics
- Tilt, Rotate & Aim

Diffused

- 2 Sizes
- Uniform Diffused Output
- Tunable White
- High Quality Diffuser

Magnetic integrated Non-Dim power supply with no remote power supply required ensuring complete inbuilt system integration



Tilt

- 2 Sizes
- Tunable White
- Multiple optics
- Stress-free anti-glare output



Blank

- Color Coated Blank Cover
- Ensures Even Look & Feel
- Hides Inner Track Vision
- Custom Cut Lengths



Grid

- 2 Sizes
- Tunable White
- Multiple optics
- Stress-free anti-glare output

Dimming Options for Modules

- Analog
- DALI
- DALI Tunable

Joule Standard Magnetic - Track

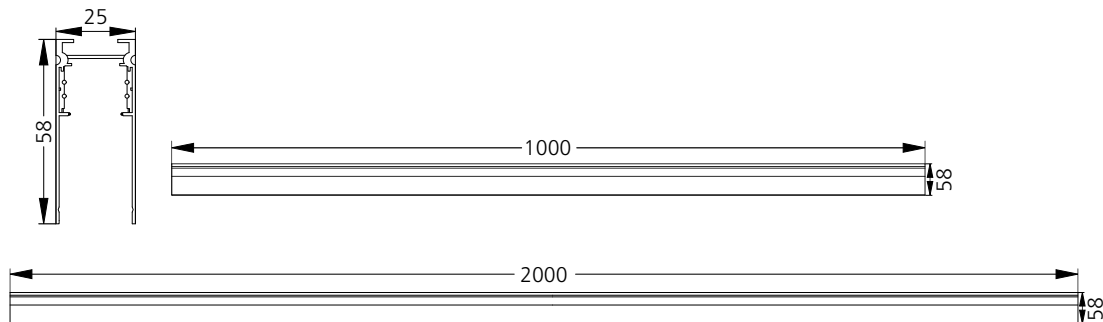
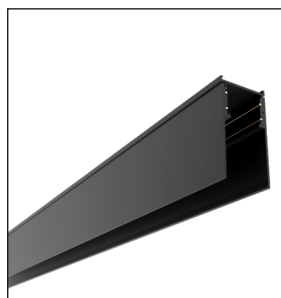

Surface Track
#2145



90° Corner



Outward Corner



Inward Corner

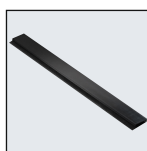

Blank Cover

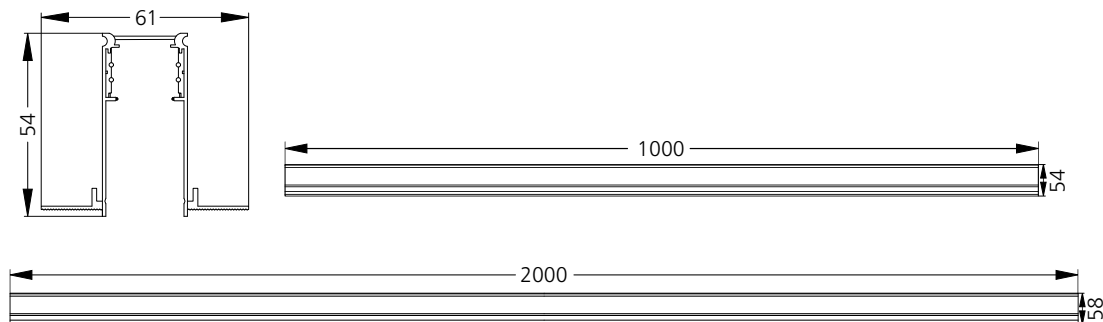
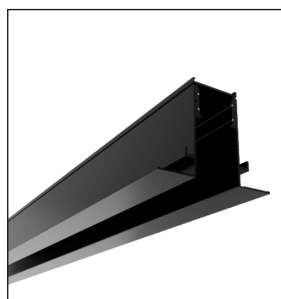

Recessed Track
#2146



90° Corner



Outward Corner



Inward Corner

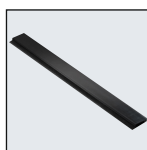

Blank Cover

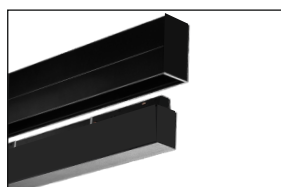

Magnetic - Power Supply
#2169

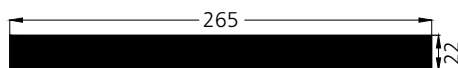
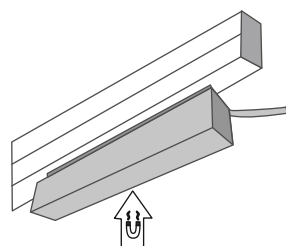

Power | 100W - 48V

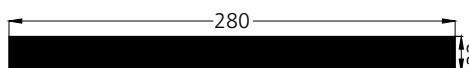

Power | 200W - 48V

Joule Standard Magnetic - Modules

LED	Typ CRI	Body Finish	Reflector Finish	IP Rating	Dimming Options	Filter Options
High Power 3 Step MacAdam L90-B10 60,000Hrs	92	Matt Black	Matt Black	IP20	Non Dim Analog Dali Dali Tunable	NA

Joule Standard Magnetic Modules Grid

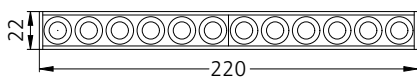

Standard M - Grid 220
#2151

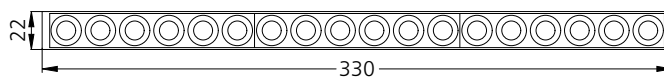

Standard L - Grid 330
#2152

Power	12W - 48V
Lumen / CCT	1050lm - 2700K 1075lm - 3000K 1110lm - 4000K Tunable White
UGR	< 19
Beam Angle	15° 24° 38°
Driver Placement	Remote

Power	18W - 48V
Lumen / CCT	1575lm - 2700K 1615lm - 3000K 1665lm - 4000K Tunable White
UGR	< 19
Beam Angle	15° 24° 38°
Driver Placement	Remote

Joule Standard Magnetic - Modules

LED	Typ CRI	Body Finish	Reflector Finish	IP Rating	Dimming Options	Filter Options
High Power 3 Step MacAdam L90-B10 60,000Hrs	92	Matt Black	Matt Black	IP20	Non Dim Analog Dali Dali Tunable	NA

Joule Standard Magnetic Modules Tilt

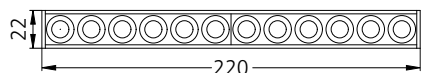

Standard M - Tilt 220
#2154

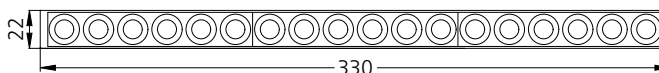

Standard L - Tilt 330
#2155

Power	12W - 48V
Lumen / CCT	1050lm - 2700K 1075lm - 3000K 1110lm - 4000K Tunable White
UGR	<19
Beam Angle	15° 24° 38°
Driver Placement	Remote

Power	18W - 48V
Lumen / CCT	1575lm - 2700K 1615lm - 3000K 1665lm - 4000K Tunable White
UGR	<19
Beam Angle	15° 24° 38°
Driver Placement	Remote

Joule Standard Magnetic - Modules

LED	Typ CRI	Body Finish	IP Rating	Dimming Options	Filter Options
Mid Power 3 Step MacAdam L90-B10 60,000Hrs	92	Matt Black	IP20	Non Dim Analog Dali Dali Tunable	NA

Joule Standard Magnetic Modules Diffused

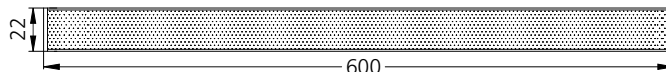
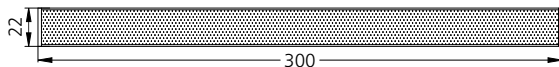
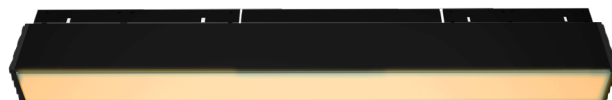

Standard M - Diffused 300
#2156

Standard L - Diffused 600
#2157

Power	10W - 48V
Lumen / CCT	815lm - 2700K 835lm - 3000K 860lm - 4000K 880lm - 6500K Tunable White
UGR	< 19
Beam Angle	Diffused
Driver Placement	Remote

Power	18W - 48V
Lumen / CCT	1465lm - 2700K 1505lm - 3000K 1550lm - 4000K 1580lm - 6500K Tunable White
UGR	< 19
Beam Angle	Diffused
Driver Placement	Remote

Joule Standard Magnetic - Modules

LED	Typ CRI	Body Finish	Reflector Finish	IP Rating	Dimming Options	Filter Options
High Power 3 Step MacAdam L90-B10 60,000Hrs	92	Matt Black	Matt Black	IP20	Non Dim Analog Dali Dali Tunable	NA

Joule Standard Magnetic Modules Wash

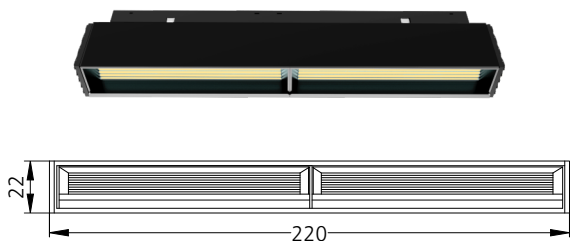

Standard M - Wash 220
#2159

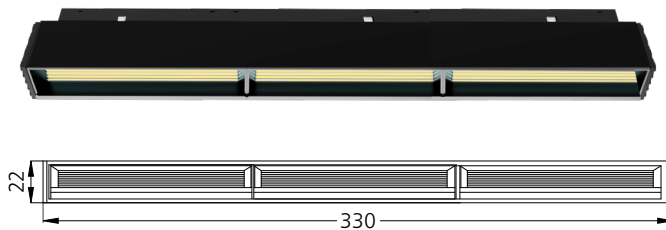

Standard L - Wash 330
#2160

Power	12W - 48V
Lumen / CCT	935lm - 2700K 960lm - 3000K 985lm - 4000K Tunable White
UGR	<19
Beam Angle	Wallwash
Driver Placement	Remote

Power	18W - 48V
Lumen / CCT	1395lm - 2700K 1430lm - 3000K 1475lm - 4000K Tunable White
UGR	<19
Beam Angle	Wallwash
Driver Placement	Remote

Joule Standard Magnetic - Modules

LED	Typ CRI	Body Finish	Interior Finish	IP Rating	Dimming Options	Filter Options
Array 2 Step MacAdam L90-B10 60,000Hrs	95	Matt Black	Matt Black	IP20	Non Dim Analog Dali Dali Tunable	Honeycomb  Tilt & Rotate

Joule Standard Magnetic Modules Spot

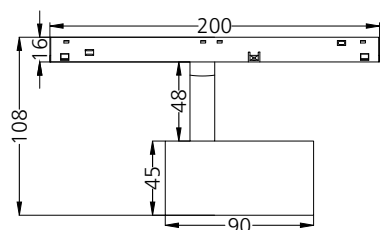

Standard S - Spot 45
#2161

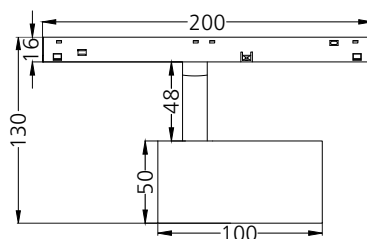

Standard M - Spot 50
#2162

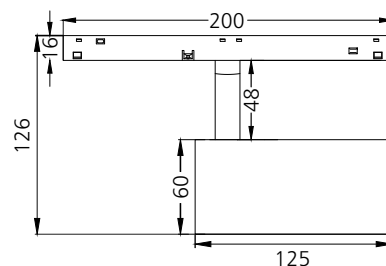

Standard L - Spot 60
#2170

	Standard S - Spot 45	Standard M - Spot 50	Standard L - Spot 60
Power	7W - 48V	12W - 48V	18W - 48V
Lumen / CCT	595lm - 2700K 610lm - 3000K 630lm - 4000K Tunable White	1025lm - 2700K 1050lm - 3000K 1085lm - 4000K Tunable White	1537lm - 2700K 1575lm - 3000K 1627lm - 4000K Tunable White
UGR	<19	<19	<19
Beam Angle	15° 24° 38°	15° 24° 38°	15° 24° 38°
Driver Placement	Remote	Remote	Remote

Joule Standard Magnetic - Modules

LED Array 2 Step MacAdam L90-B10 60,000Hrs	Typ CRI 95	Body Finish Matt Black	Interior Finish NA	IP Rating IP20	Dimming Options Non Dim Analog Dali Dali Tunable	Filter Options Honeycomb
---	---------------	---------------------------	-----------------------	-------------------	---	-----------------------------

Joule Standard Magnetic Modules Disc



Tilt & Rotate

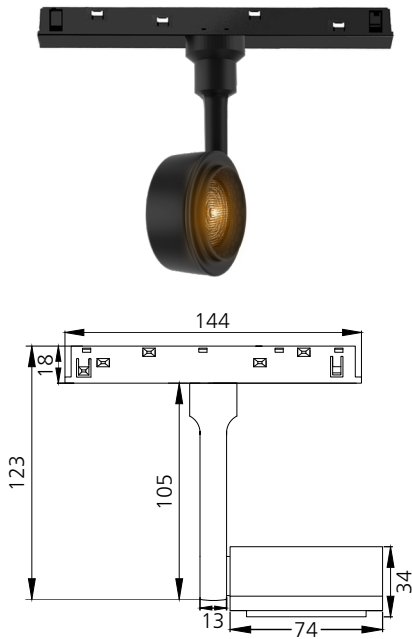

Standard - Disc S
#2249

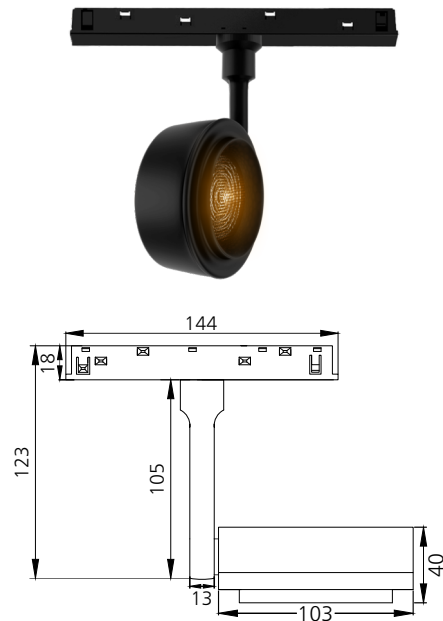

Standard - Disc M
#2250

10W - 48V
830lm - 2700K
850lm - 3000K
875lm - 4000K
Tunable White
< 19
15° 24°
38°
Remote

18W - 48V
1494lm - 2700K
1530lm - 3000K
1575lm - 4000K
Tunable White
< 19
15° 24°
38°
Remote

Joule Decorative

LED	Typ CRI	Body Finish	Interior Finish	IP Rating	Dimming Options	Filter Options
High Power 3 Step MacAdam L90-B10 60,000Hrs	92	Matt Black Transparent Glass	Specular Matt Gold	IP20	Non Dim	NA

Joule Decorative

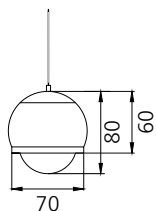

Decorative - Raindrop
#2242

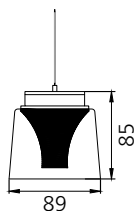

Decorative - Halo
#2243

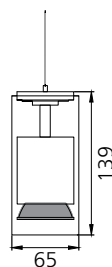

Decorative - Celestial
#2244



Decorative - Moonbeam
#2245

Power	5W - 48V
Lumen / CCT	405lm - 2700K 412lm - 3000K 420lm - 4000K
UGR	< 19
Beam Angle	80°
Driver Placement	Remote

Power	4W - 48V
Lumen / CCT	324lm - 2700K 329lm - 3000K 336lm - 4000K
UGR	< 19
Beam Angle	120°
Driver Placement	Remote

Power	5W - 48V
Lumen / CCT	405lm - 2700K 412lm - 3000K 420lm - 4000K
UGR	< 19
Beam Angle	24°
Driver Placement	Remote

Power	5W - 48V
Lumen / CCT	405lm - 2700K 412lm - 3000K 420lm - 4000K
UGR	< 19
Beam Angle	15° 24° 38°
Driver Placement	Remote

The Decorative Fixtures are common to Joule Invi, Joule Discreet & Joule Standard Series.